



US00D741971S

(12) **United States Design Patent**
Roberts

(10) **Patent No.:** **US D741,971 S**

(45) **Date of Patent:** **** Oct. 27, 2015**

(54) **FLAGSTICK REFLECTOR MODULE**

(71) Applicant: **PRESTIGE FLAG MFG. CO., INC.**,
San Diego, CA (US)

(72) Inventor: **Mike Roberts**, San Diego, CA (US)

(73) Assignee: **PRESTIGE FLAG MFG. CO., INC.**,
San Diego, CA (US)

(**) Term: **14 Years**

(21) Appl. No.: **29/492,989**

(22) Filed: **Jun. 4, 2014**

(51) **LOC (10) Cl.** **21-02**

(52) **U.S. Cl.**

USPC **D21/789**; D10/111

(58) **Field of Classification Search**

USPC D10/111, 113.1, 113.4, 109.1,
D10/114.1-114.2, 114.4, 70; D26/97, 91,
D26/28, 37; D11/182, 165, 181; D20/41;
D21/789

CPC F21V 7/00
See application file for complete search history.

(56) **References Cited**

U.S. PATENT DOCUMENTS

2,362,131	A	11/1944	Haggart, Jr.
D242,775	S	12/1976	Williams, Jr.
4,136,394	A	1/1979	Jones et al.
4,813,494	A	3/1989	Beard et al.
4,905,624	A	3/1990	Krolzick
5,301,435	A	4/1994	Buckley
5,311,271	A	5/1994	Hurt et al.
D371,084	S	6/1996	Ogawa
D379,436	S	5/1997	Palmer
5,723,840	A	3/1998	Bojic et al.
5,760,909	A	6/1998	Nichols
D397,047	S	8/1998	Plitman
5,841,392	A	11/1998	Kishimoto
6,062,985	A	5/2000	Rege
6,185,055	B1	2/2001	Feist

6,209,429	B1	4/2001	Urso et al.
6,266,628	B1	7/2001	Huep et al.
6,346,055	B1	2/2002	Rege
D465,174	S	11/2002	Ursprung
D477,787	S	7/2003	Plitman
D526,930	S	8/2006	Plitman
D536,637	S	2/2007	Plitman

(Continued)

OTHER PUBLICATIONS

Internet World Wide Web Page, <http://www.laserlinkgolf.com>,
printed Nov. 23, 2004.

(Continued)

Primary Examiner — George D Kirschbaum

(74) *Attorney, Agent, or Firm* — Sheppard Mullin Richter &
Hampton LLP

(57) **CLAIM**

I claim the ornamental design for a flagstick reflector module,
as shown and described.

DESCRIPTION

FIG. 1 is a first perspective view of a flagstick reflector module
embodying the new design.

FIG. 2 is a first side view of the flagstick reflector module
embodying the new design.

FIG. 3 is a second side view of the flagstick reflector module
embodying the new design.

FIG. 4 is a third side view of the flagstick reflector module
embodying the new design.

FIG. 5 is a fourth side view of the flagstick reflector module
embodying the new design.

FIG. 6 is a top view of the flagstick reflector module embody-
ing the new design; and,

FIG. 7 is a bottom view of the flagstick reflector module
embodying the new design.

The broken line showing of a flag pole is included for the
purpose of illustrating portions of the "article" and forms no
part of the claimed design.

1 Claim, 4 Drawing Sheets

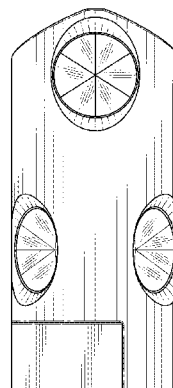
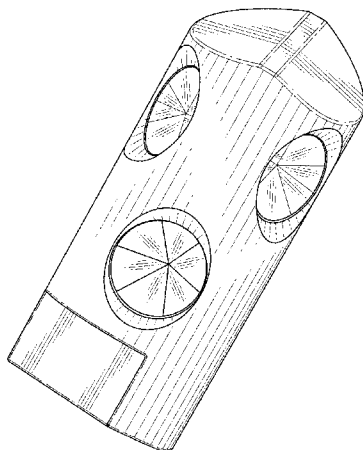

(56)

References Cited

U.S. PATENT DOCUMENTS

7,215,412 B2 5/2007 O'Loughlin et al.
D546,243 S 7/2007 O'Loughlin et al.
D549,131 S 8/2007 Plitman
D550,120 S 9/2007 Plitman
D564,405 S 3/2008 O'Loughlin et al.
D600,754 S * 9/2009 Flanagan et al. D20/41
2001/0019101 A1 9/2001 Ohtomo et al.
2002/0093151 A1 7/2002 Monge
2004/0031433 A1 2/2004 Cardarelli

2004/0223139 A1 11/2004 Vogel
2005/0272515 A1 12/2005 Hurley et al.
2007/0171394 A1 7/2007 Steiner et al.

OTHER PUBLICATIONS

Internet World Wide Web Page, http://www.mosquitocreekoutdoors.com/cgi-bin/SoftCart.exe/golf_gps.htm?E+scstore, printed Aug. 4, 2004.
Internet World Wide Web Page, <http://www.laserlinkgolf.com/smartyPressRelease.htm>, dated Jan. 12, 2005.

* cited by examiner

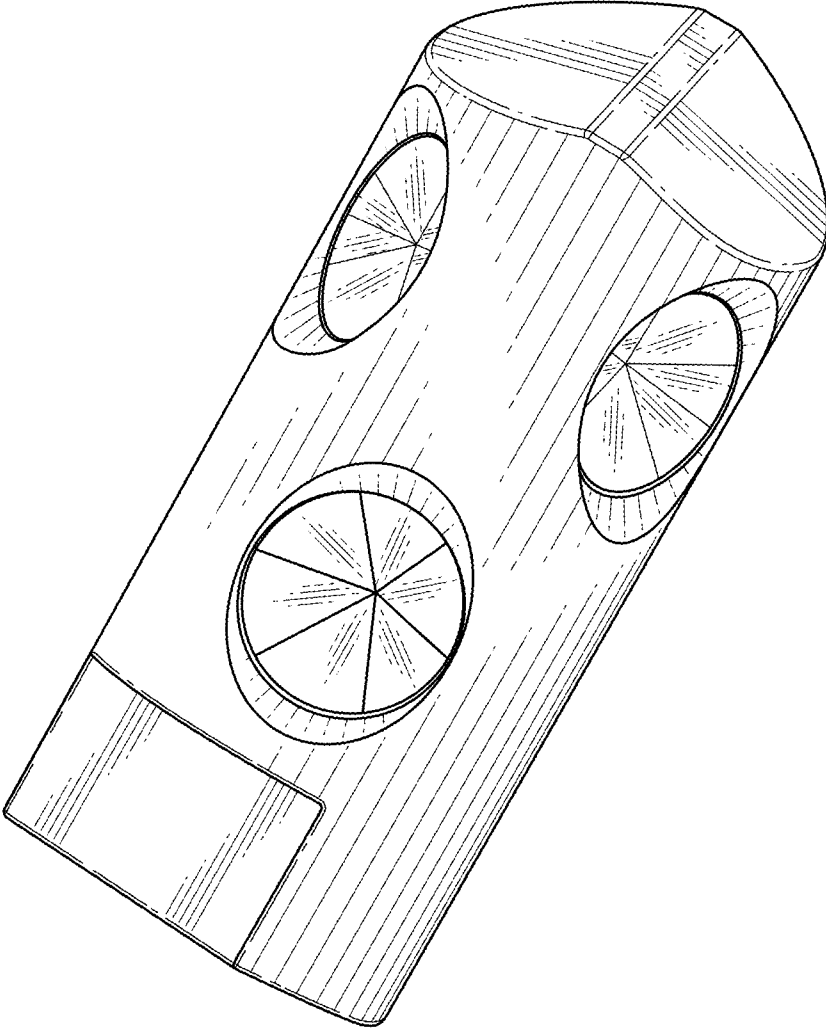

FIG. 1

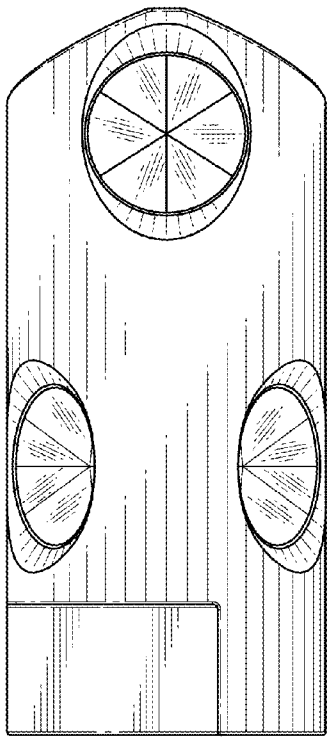

FIG. 2

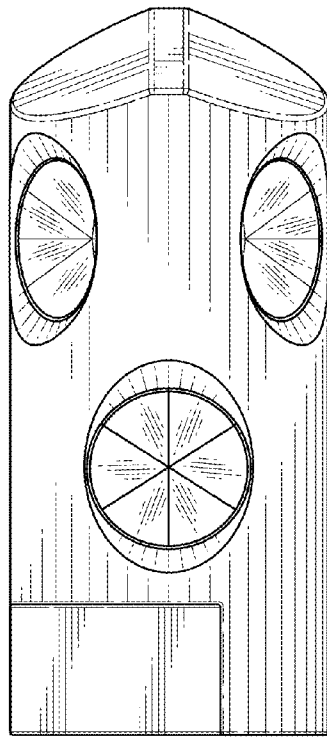

FIG. 3

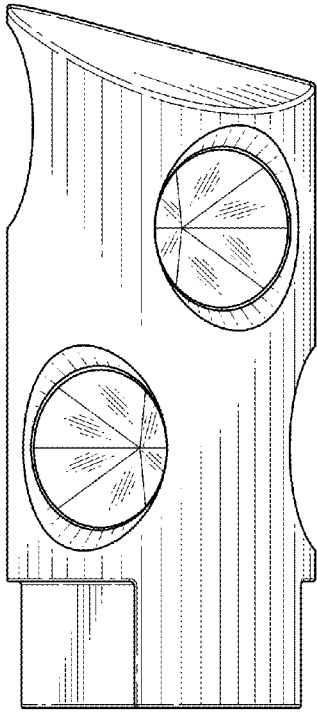

FIG. 4

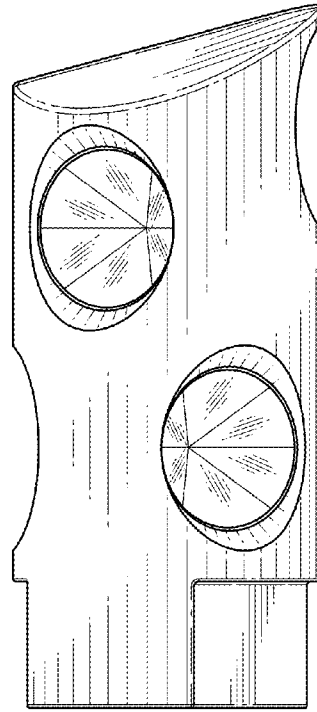

FIG. 5

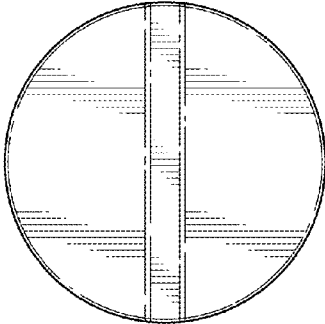

FIG. 6

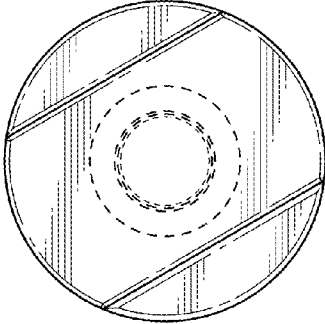

FIG. 7